

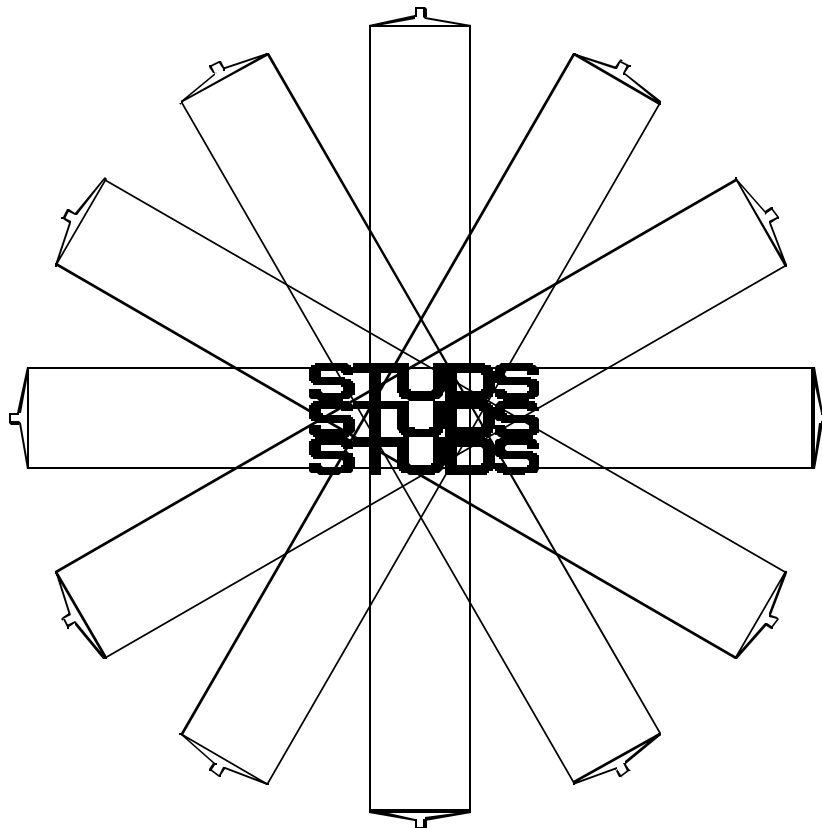

Welder's guide to Gap CD Welding

September 1994 Revision 0



© 1994 IMAGE INDUSTRIES INC. All rights reserved. Information in this document is subject to change without notice. No Part of this document may be reproduced or transmitted in any form or by any means electronic or mechanical, for any purpose, without the express written permission of IMAGE INDUSTRIES INC.

Table of Contents

What is CD Welding?.....	3
Steps in Contact CD Welding	3
Visual Inspection of CD Welds.....	4
Problems with Contact CD Welding	4-5
Problems with Gap Welding	5
Adjusting the Stud Gun for Gap Mode.....	6
Recommended Equipment Settings	7
Physical Inspection of Weld Studs.....	8
Maintenance of a Stud Welding System	9
Personal Safety Precautions	10-11
Definitions of Stud Welding Terms	12-14

OTHER INFORMATION:

“Welding Handbook,” Eighth Edition, Volume 2. O’Brien, R.L., Editor, ©1991. Chapter 9 “ Stud Welding”, American Welding Society.

“Fusion Welding: A Unique Joining Process”, MAN; April 1994 p 36

IMAGE INDUSTRIES, the IMAGE logo and the Studs logo are trademarks of IMAGE INDUSTRIES INC.

Nelson, TR1600, NS-20, NS-20HD and NS-30 are registered trademarks of TRW

What is CD Welding?

To understand gap capacitor discharge (CD) welding it is useful to understand contact CD welding first because the principles of gap CD welding build on those of contact CD welding.

A technical definition might read something like: Capacitor Discharge welding, sometimes known as fusion welding, is essentially a controlled short circuit where charged electrolytic capacitors short out through an initiation nib that is integrated with the stud. HUH? Let's look at that in English.

Steps in Contact CD Welding

- The first step in CD Welding is turning on the power supply. When turned on, the capacitors inside the power supply charge up. These capacitors are HUGE and can store a lot of electrical energy. There are 6-9 of them depending on the particular power supply.
- A stud is loaded into the gun.
- The gun is positioned against the base metal. Note the stud is connected to the negative terminal on the power supply and the base metal is "grounded" to the positive terminal (Stud welding is a positive ground system). An electrical path is created through the tip of the stud.
- The gun trigger is pulled. This creates the electrical short circuit and releases, or discharges, all the stored energy in the capacitors.
- The tip or nib on the stud is too small to handle the system current (up to 3,600 amps in some cases). As this tip vaporizes (similar in function to a fuse) it creates an electrical path which establishes an arc.
- The arc melts the bottom of the stud and a portion of the base metal. At the same time the spring pressure in the gun drives the stud into the molten pool of metal.
- The molten metal cools and completes the weld cycle. This happens in less than .012 seconds.

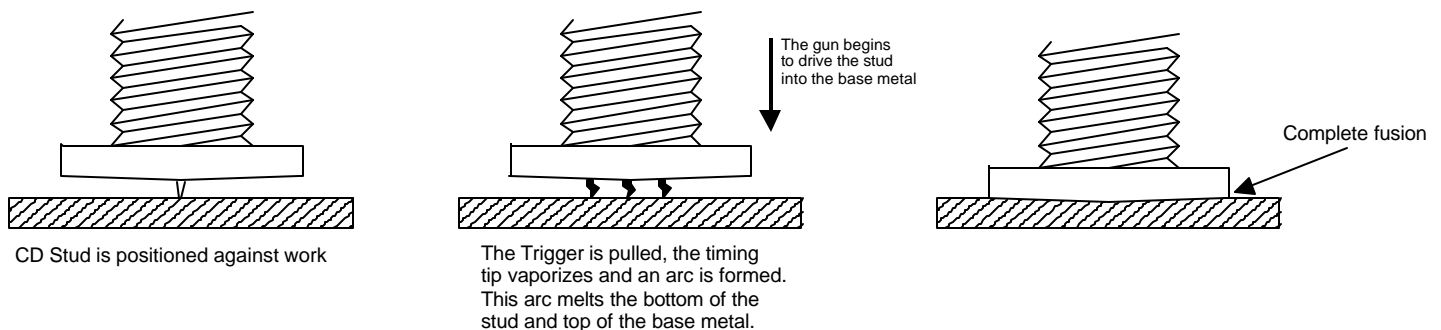

Visual Inspection of CD Welds

Hot Weld	Excessive weld metal splattered around the weld base
Cold Weld	No molten metal forming a fillet
Good Weld	Some molten metal forming a small fillet around the stud flange

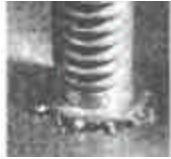

Good Weld



Hot Weld



Cold Weld

Problems with Contact CD Welding

There are two basic areas where CD welding can go wrong:

1. Not enough metal is melted to form a good bond (Cold Weld)
2. The molten metal cools before a bond is made. (Cold Plunge)

Not enough metal is melted to form a good bond (Cold Weld)

If there is not enough metal melted, fusion can not take place. There are many causes of incomplete melting.

Factors Outside of Operator Control

- Improperly formed initiation nib on stud due to manufacturing process.
- Changes in alloys being welded
This can usually be compensated for by changing the settings on the power supply.
- Equipment failure due to many possible causes including:
 - leaky capacitor(s)
 - malfunctioning output SCR
 - malfunctioning output control board
 - other misc. electrical problems

Factors With in Operator Control

- Improperly formed initiation nib on stud crushed do to excessive pressure.
(sometimes, especially with aluminum studs, an operator can apply repeated pressure to the stud nib and crushes or shortens the nib. The shorter nib reduces arc length/time and does not properly melt the stud and/or base material)
- Coiled weld or ground cables
This reduces weld current delivered to the stud. The coil cables act like a large inductor and inhibit the flow of energy.
- Improperly Set Power Supply Controls
Always use the equipment manual, or the back of this booklet as a baseline for set up of the power supply.

The molten metal cools before a bond is made (Cold Plunge)

If the molten metal cools before the stud and base material are forced together there is little chance that the stud will be properly fused. After the stud is broken off the appearance will be shiny.

Factors Outside of Operator Control

- Springs inside of gun have fatigued and do not apply the same pressure
- Dirt inside of the gun prevents smooth operation and hangs up or slows gun motion
Either of these MAY be compensated for by increasing spring pressure

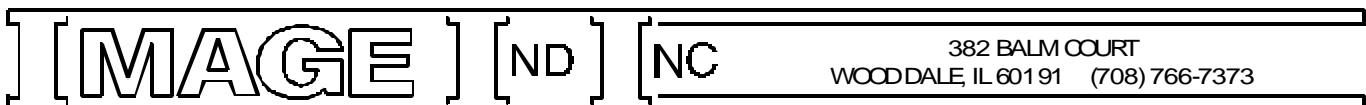

The Molten Metal cools before a bond is made (Cold Plunge) Continued

Factors With in Operator Control

- Improperly set spring pressure
- Varying gauges of sheet metal (settings can be adjusted, this is especially true for aluminum)

Why is Gap Better on Some Materials (like Aluminum)?

The usual problem with metals other than steel is not the cold weld. The typical problem is the cold plunge or that the molten metal cools before the stud gets to the metal.

Why does this happen? Aluminum is an excellent conductor of heat. A large, or thick piece of aluminum can absorb the heat created by a stud weld before the stud gets into the molten pool of metal.

So how can you work around this problem? In contact CD welding you probably used a stiffer spring (black or red). This stiffer spring forced the stud into the weld pool faster. However, with the heavy spring and a soft aluminum stud the weld tip has the potential for getting crushed.

Gap stud welding does 2 good things

- Places no pressure on the stud, so the tip doesn't get crushed.
- Gives the stud a "running start" so in can get into the molten weld pool quickly.

The graph to the right shows that gap welding is about twice as fast as contact welding. One result of this increased speed is the welding current increases. This happens because current is essentially energy over a period of time. In gap mode you are using the same energy over a shorter period of time so the effective current is increased.

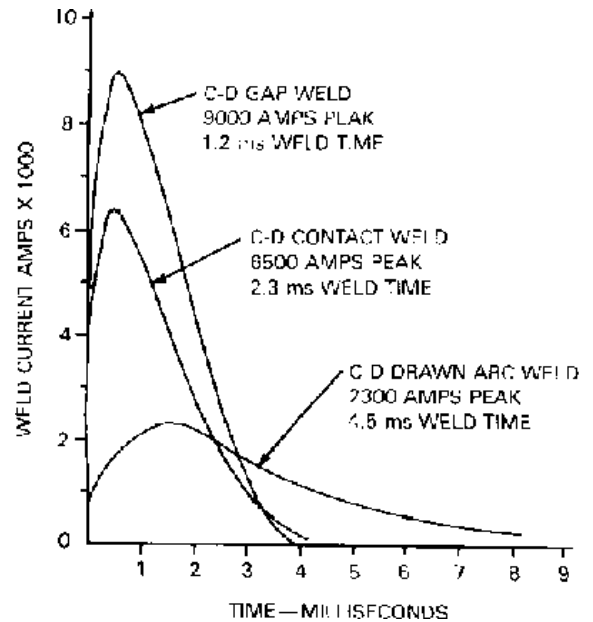

Problems with Gap Welding

Many of the problems associated with gap welding are the same as those with contact CD welding. We will examine the different failure modes and possible correction for each.

Hot Weld: Characterized by excessive weld splatter

Increase the Gap Distance	This speeds up the weld time (faster drop time) and the faster drop time extinguishes the arc sooner.
Decrease Voltage	Obviously, reducing the voltage reduces the overall energy into the weld
Decrease Capacitance	Reducing capacitance reduces the amount of energy that can be stored so there is less energy available for the weld.
Increase Spring Pressure	This also speeds up the weld time and extinguishes the arc sooner.

Cold Weld: Characterized by almost no weld spatter and apparent undercut on the weld base.

These suggested corrections will be the exact opposite of those above.

Decrease the Gap Distance	The shorter distance reduces the drop speed. The slower drop speed allows for a longer arc or weld time.
Increase Voltage	Increasing voltage increases the overall weld energy
Increase Capacitance	Increased capacitance increases the amount of stored energy available for weld
Decrease Spring Pressure	This also reduces the drop speed and provides a longer weld time

Cold Plunge: Characterized by a shiny surface after stud has broken off

Increase Gap Distance	This increases drop speed and gets the stud into the molten pool faster.
Increase Spring Pressure	This increases drop speed and gets the stud into the molten pool faster.
Increase Capacitance & Decrease Voltage	This will increase the arc duration and create a deeper weld pool
Remove Combo Cable	This can reduce the amount of weld energy flowing especially in gap mode because of the high current spike.

Adjusting the Stud Gun for Gap Mode

Before making any adjustments it is important to disconnect the stud gun's weld cable from the unit's power supply to prevent any accidental discharge. Note: the unit must be on to hold the gun in the gap position.

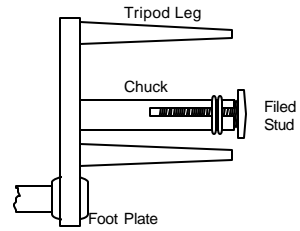
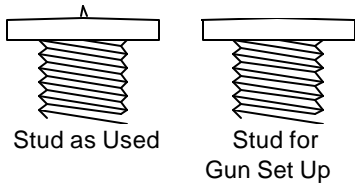

Step 1: File the tip of the stud off.

Step 2: Insert the stud into the chuck and lock the gun in the gap position

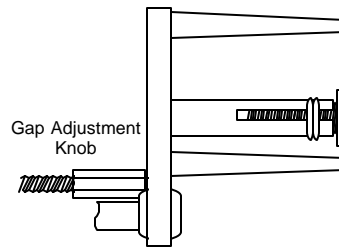
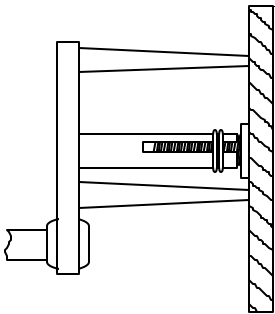

Step 3: Align the stud with the end of the legs by placing it against a flat surface. This is "zero" gap.

Step 4: Turn the Gap Adjustment knob so it is flush with the back of the foot plate.

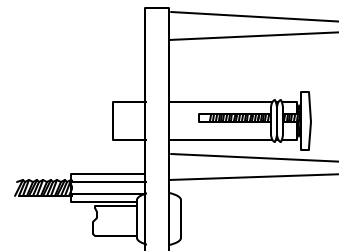
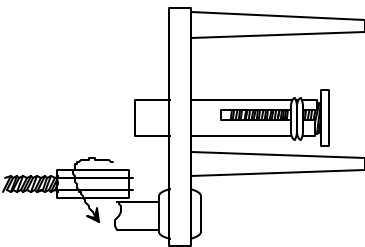

Step 5: Release the leg and foot assembly and move it away from the gap adjustment knob. Turn the adjustment knob outward (use the table on the next page) the proper number of turns to set the proper gap.

Step 6: Reposition the leg and foot assembly back against the gap adjustment knob. The gap is now properly set.

Nelson Model 2500 Gap Mode Settings

Stud Size	Stud Material	Base Material	Gap Inches	Gap Adjustment Knob	Voltage	Spring Pressure	Capacitance
#6	Carbon Steel	Carbon Steel	.120	3 Turns	120	20%	49K µf
	Stainless Steel	Stainless Steel	.120	3 Turns	120	50%	49K µf
	Aluminum	Aluminum	.130	3 Turns 1½ Flats	160	Min.	16K µf
#8	Carbon Steel	Carbon Steel	.120	3 Turns	130	Min.	49K µf
	Stainless Steel	Stainless Steel	.120	3 Turns	130	50%	49K µf
	Aluminum	Aluminum	.130	3 Turns 1½ Flats	140	50%	49K µf
#10	Carbon Steel	Carbon Steel	.120	3 Turns	140	Min.	49K µf
	Stainless Steel	Stainless Steel	.120	3 Turns	130	Min.	49K µf
	Aluminum	Aluminum	.130	3 Turns 1½ Flats	160	40-60%	49K µf
1/4	Carbon Steel	Carbon Steel	.120	3 Turns	130-140	Min.	97K µf
	Stainless Steel	Stainless Steel	.120	3 Turns	130	Min.-20%	97K µf
	Aluminum	Aluminum	.110-.130	2 Turns 4½ Flats- 3 Turns 1½ Flats	190	Min.-40%	49K µf
5/16	Carbon Steel	Carbon Steel	.080	2 Turns	180	Min.	97K µf
	Stainless Steel	Stainless Steel	.080	2 Turns	180	50%	97K µf

Physical Inspection of Weld Studs

Physical tests should be performed as part of the qualification procedure before beginning production welding to ensure the set-up parameters are correct. This should be done at the beginning of a new shift or after changing stud diameters or materials.

Physical tests are destructive and should be done only on test plates.

Suggested physical tests are as follows:

1. Bend Test The stud to be tested should be bent 15° away from its weld axis and back to 0° or until failure occurs. Bending can be done with a hammer or with the aid of a bending tool such as a tube or pipe. Failure should occur in the stud material itself or, on thin plate, a plug of base metal should be torn out.
2. Torque Test The stud should be torqued until a pre-specified load is attained or until the stud fails. Failure should occur in the stud material itself or, on thin plate, a plug of base metal should be torn out.
3. Tensile Test There are many commercially available "stud pullers". This device grabs onto the stud and pulls it away from the base metal. This can be a good tool when there is uncertainty about weld strength. This can test a stud to failure which can be used as a qualification test. Also the stud can have a tensile load to a predetermined limit. Testing to the predetermined limit can be used as a periodic quality test for production. Note: on thinner base metals this test may actually pull the base metal and cause a reverse side dimple so the predetermined limit must take into account the base metal thickness.

Maintenance of a Stud Welding System

A majority of the maintenance of an stud welding system is in:

- 1.) Stud welding gun
- 2.) Welding cable
- 3.) Control cable

These items simply receive the most wear.

CABLE MAINTENANCE

When checking cables for continuity it is important to slightly pull on all the connectors so that if there is a break the wires will be pulled apart. The continuity check can be performed with a standard Ohm meter. All cables: ground, control and weld cables should be periodically inspected.

Also, the cables themselves should be closely inspected for any snags or kinks that could be causing a problem. Insulation around the cable should be periodically checked for wear to ensure proper safety. Finally, for operator convenience, the control cable and the weld cable should be fastened together (electrical tapes works well) to help movement of the gun.

GUN MAINTENANCE

The gun, since it carries out most of the welding functions, should be periodically (at least every 3 months) disassembled and cleaned. Special attention should be given to the lifting or locking mechanisms. This shaft must be absolutely free with no binding inside the gun and there should be no contact between the stud and the ferrule or spark shield. Never lubricate the lifting or locking mechanisms. It should be cleaned with a dry cleaner such as electrical contact cleaner. Caution should also be exercised when reassembling the gun to be certain not to pinch wires or the weld cable. This could cause erratic welding problems which are usually difficult to isolate.

Note: on Gap CD units the front cover has an internal ground connection. The unit will not function if this connection is broken. Care must be taken when reassembling the front cover.

CONTROLLER MAINTENANCE (Arc Stud Welding Systems Only)

To check the controller, you simply free-air trigger the gun at various time settings. If the amount of time that the gun stays lifted corresponds to the time you set on the unit, the timing module is usually good. *NOTE: if your unit has a "Lift Check" button on the controller this must be pressed in to check the timing functions.*

Power Supply Maintenance

The power supply contains electronic control boards. Normally, these items do not require maintenance. However, in harsh environments, particularly those with grinding or sanding, metallic dust can enter the welder. This conductive metallic dust can cause unexplained problems with the welding system. Periodically removing the power supply cover and blowing out the power supply is a good idea. Frequency will vary depending on the environment. (always disconnect power before opening any power supply. CD units will continue to store energy aver they have been unplugged. Make sure all energy is discharged before blowing out power supply).

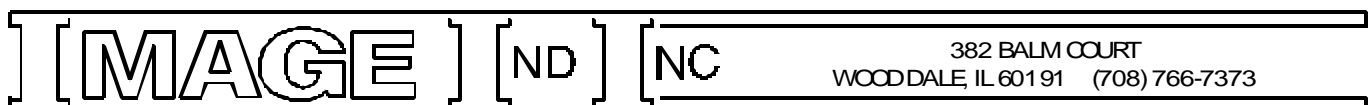

PERSONAL SAFETY PRECAUTIONS

- A) If the power source has a stick welding mode the output terminals and any tools connected are always electrically “hot”. In stud welding mode the output terminals are electrically “hot” only while welding. Use only the proper tool with the selected welding mode.
- B) **Always protect yourself from possible electric shock.**
- 1) Never allow contact between the electrically “hot” portions of the circuit and your bare skin or wet clothing. Wear dry, hole-free gloves to insulate your hands.
 - 2) Always insulate yourself from ground by using dry insulation when welding in damp locations or metal floors, gratings or scaffolds and particularly when large areas of your body can be in contact with possible grounds such as sitting or lying down.
 - 3) Maintain all the equipment such as stud gun, electrode holder, ground clamp, welding cable and welding machine in good, safe operating condition.
 - 4) NEVER dip the stud gun or electrode holder in water for cooling.
 - 5) If two welders are connected together, the open circuit voltage can be the sum of the two. Never touch the electrically hot portions of the circuit.
 - 6) If the welder is used as a power supply for automatic welding, there same precautions are applicable to the automatic unit.
- C) When working above floor level, protect yourself from a fall should you get a shock or startled. Never wrap the electrode cable around any part of your body.
- D) **Arc burn may be more severe than sunburn.**
- 1) When stud welding, safety goggles should be worn by the operator. A shaded No. 3 lens is suggested.
 - 2) When stick welding, arc-air gouging, or observing the same, use a head shield with the proper filter and cover plates to protect your face and eyes from sparks and the ultraviolet rays of an arc. The filter lens should conform to ANSI Z87.1 standards.
 - 3) Use suitable clothing to protect your skin and that of people around you from the arc rays and sparks.
 - 4) When stick welding or arc-air gouging, protect nearby personnel with suitable, non-flammable screening and warn them not to watch the arc or expose themselves to the arc rays, hot spatter or metal.
- E) Droplets of molten slag and metal are thrown or fall from the welding arc. Protect yourself with oil free protective garments such as leather gloves, heavy shirt, cuffless trousers, high shoes and a cap to cover your head. When welding out of position, or in confined areas, wear ear plugs.
- F) When in a welding area, always wear safety glasses. Safety glasses with side shields are a must when near a slag chipping area.
- G) Move fire hazards to a place safely away from the welding area. Welding sparks and hot materials generated at the welding arc will go through small cracks and openings into adjacent areas.

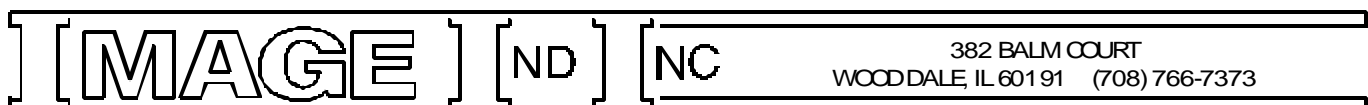

PERSONAL SAFETY PRECAUTIONS (Continued)

- H) When not manual arc welding, place the welding tool where it is insulated from the ground system. Accidental grounding can cause overheating and create a fire hazard.
- I) Connect the ground cable as close to the welding area as practical. Ground cables connected to the building framework or other locations some distance from the welding area increase the possibility of the welding current passing through lifting chains, crane cables or other alternate circuits. This creates fire hazards. Overheating of lifting chains or cable can cause them to fall.
- J) Welding can produce hazardous fumes and gasses. Use adequate ventilation and avoid breathing these fumes and gasses. Welding on galvanized, lead or cadmium plates produces toxic fumes.
- K) No welding should be done in locations near chlorinated hydrocarbon vapors such as degreasing and painting stations. The heat and rays of the arc can react with the solvent vapors to form phosgene, a highly toxic gas, and other irritating by-products.
- L) Do not heat, weld or cut tanks, drums or containers until the necessary steps have been followed to insure that no flammable, irritating or toxic vapors can be formed by the residue.
- M) Vent hollow castings or containers before heating, cutting or welding. A pressure build up may cause it to explode.
- N) For more detailed safety information, consult the pamphlet, "Welding Safety", published by the U.S. Department of Health, Education and Welfare, DHEW (NIOSH), Publication No. 77-131. It is also recommended that you purchase, read and follow the directions of "Safety in Welding & Cutting, ANSI Standard Z49.1" for \$5.00 from the American Welding Society, Miami, Florida, 33125.

POWER SUPPLY SAFETY PRECAUTIONS

- A) Always connect the frame of the power supply to ground in accordance with the National Electrical Code and the manufacturer's recommendations.
- B) Installation, servicing or trouble shooting should only be done by qualified personnel trained to work on this type of equipment.
- C) Before servicing any piece of equipment, turn off the disconnect switch at the fuse box.
- D) When operating, all covers must be on the equipment.

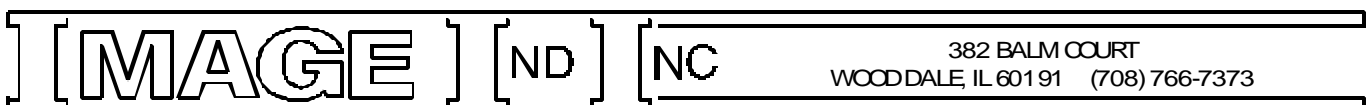

Definitions of Stud Welding Terms

Amperage	See Current
Arc-Blow	The effect where the weld fillet runs away from the ground connection. The electric fields generated during the weld repel the fillet material away from the location of the ground. If this is a concern, it can frequently be addressed through the use of double grounds.
Bellows	This is the rubber boot that slides over the chuck adapter. This helps to keep dirt, weld spatter and other foreign contaminants from entering the internal gun mechanism.
Burn-Off	The amount of stud consumed during the weld. This “burn-off” material forms the weld fillet.
Burn Through	A condition where the weld excessively distorts or actually melts through the base material. This is caused by an excessively hot weld or by using base material that is too thin.
Capacitor	A passive electrical component that stores electrical energy
Chuck	The device that holds the weld stud during the welding process. It fits into the chuck adapter. This is a consumable component and should be replaced when worn.
Chuck Adapter	This component of the stud gun holds the chuck and connects to the internal lifting mechanisms. The weld current flows from the weld cable to the lifting mechanism to the chuck adapter to the chuck and finally into the stud.
Cold Plunge	A condition where the molten weld pool has cooled prior to the stud being pushed into the weld pool.
Cold Weld	Not enough weld energy was used in the welding process. Typically this is characterized by reduced or no fillet and apparent undercutting.
Control Cable	This is the thin cable that connects the stud gun to the controller. This cable carries the trigger signal from the gun to the controller and the lifting voltage back from the controller to the gun.
Controller	The controller initiates the pilot arc, sends the lift signal to the stud gun, starts the weld current at the right instant, and controls the duration of the weld. The controller can be a separate “box” or an internal component as in self contained units.
Current	<p>The flow of electricity is referred to as current and is expressed in Amperes (Amps). There are two types of current: Alternating Current (AC) and Direct Current (DC). Direct current always flows one way: from negative to positive. DC is polarized which means there is a definite negative and positive connection. Alternating current (the type you get from a wall socket) flows back and forth. AC is non-polarized, you can reverse the connections and not alter anything. <u>Stud Welding uses DC current.</u></p> <p>It should be noted that current is an electron flow. The amount of current required determines the size (diameter) of the cable needed. The larger the cable the more current it can carry. See resistance.</p>
Discharge	The release of electrical energy, typically used in reference to capacitors.
Ferrule	A ceramic shield used in arc stud welding. The purpose of the ferrule is to contain sparks, heat and molten metal in the weld zone while keeping gasses and impurities out.

Definitions of Stud Welding Terms

Ferrule Grip	Holds the ferrule during the weld sequence. This is a consumable item and should be replaced when worn.
Fillet	The ring of weld metal that surrounds the stud after welding.
Flux Ball	The flux load press into the end of most weld studs. During the weld process the flux load vaporizes and consumes the oxygen at the weld site. This helps to eliminate contaminates in the weld itself.
Foot	This stud welding component is attached to the legs and it holds the ferrule grip. The combination of the legs, foot and ferrule grip determine plunge.
Ground	All equipment should be grounded (the exception is double insulated equipment). The reason for grounding is that the voltages used are always at a potential level different from the ground, and if a good conduction path is established between the equipment and the ground there can be no potential difference developed between the equipment and anyone who is standing on the ground. thus, if any voltage is leaked it will be conducted away through the ground path rather than through the operator. For the equipment to be properly grounded you must be able to read continuity (no resistance between the ground pin on the plug and any conductive surface on the equipment).
Gun	See Stud Gun
Hang Up	A condition where the stud gun does not plunge the stud into the weld pool properly and only a partial weld occurs. This can be caused by the internal mechanisms binding or more commonly by the stud hitting the ferrule. Remedy by adjusting the foot.
Hot Weld	Too much energy was used during the welding process. This is characterized by excessive splatter (CD) or a washed out fillet (Arc)
Lift	This motion is essential to the stud weld process since it creates a gap which the current must bridge. This air-gap increases the electrical circuit resistance and generates the heat necessary to melt the stud and parent material for the weld. If no gap exists there would be a direct short to the base material and sufficient heat would not develop. Short lift may cause molten metal to bridge the arc gap and seriously hamper weld quality. Excessive lift may result in the arc being interrupted and inconsistent which can cause poor weld results. See resistance.
Pilot arc	This is the initiating arc which is first formed while the stud is being lifted off the work. It establishes the path for the weld current.
Plunge	The amount of stud, typically 1/8", which protrudes beyond the ferrule when the stud gun is in its normal state. This represents the portion of the stud to be used in forming the weld fillet (Arc). Short plunge may cause incomplete fillet formation while too much plunge may cause excessive splatter which may also leave incomplete fillets or uneven fillet formation.

Also, used to describe the dropping action of the gun. As in: *The stud is now plunging into the base metal*

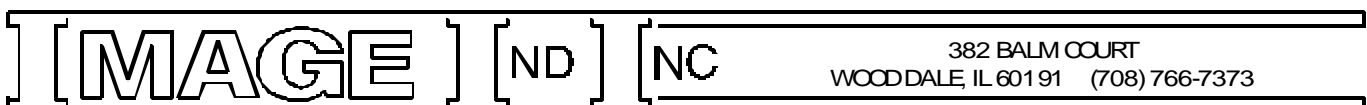

Definitions of Stud Welding Terms

Plunge damper	A device which slows the rate which a stud plunges into the weld pool. This reduces the amount of splash from the molten metal and helps to form a uniform weld fillet. This typically is only necessary for stud diameters over ½”.
Power Supply	The power supply can be external, such as a generator or a transformer-rectifier. Ideally, it should have an open-circuit DC voltage in the 70-120 volt range. The current required depends on the stud diameter to be welded. A general rule of thumb is 100 amps for every 1/16” diameter. For example: a 1/4” stud will require 400 amps of weld current. A power supply can also be internal and are call self contained units. Smaller units (1/2” diameter stud capacity) usually hook up to 220 or 440 volt single phase power. Larger units require 220 or 440 volt three phase power.
Protrusion	See plunge.
Resistance	Resistance is the opposition to current flow and is expressed in Ohms. The more resistance the more Ohms. Whenever electrical flow is impeded by resistance heat is generated (it is this heat that allows stud welding to work). For example, a 40 foot cable will have twice the resistance of a 20 foot cable of the same type.
SCR	<i>Silicon Controlled Rectifier.</i> An active electrical device which can be turned on and off to allow the passage of current. An electronic switch.
Spark Shield	CD welding and some Short cycle arc welding. This is a shield to reduce visible flash and to contain any spatter generated during weld
Stud Gun	This is the unit the operator holds. It is connected to the controller via the control cable and to the power supply via the weld cable. Besides holding the stud, the gun handles the lift, plunge and trigger functions. In other words, the gun tells the controller when to begin the weld cycle, the it executes all the weld functions from the controller to complete the cycle
Time	This is the duration of the weld. The general rule is that as the stud diameter increases, the weld time is increased. In cases where there is limited base material thickness, shorter than normal weld time is used and the amperage is increased to give sufficient heat to the weld.
Voltage	Is the electrical potential difference from one point to another. Electrical current flow is the result of an electrical path (such as a wire) being established between two points of different potential, or voltage levels. If the potentials are continually interchanging and the current flows back and forth, it is AC voltage. This is the type of voltage a generator would provide. On the other hand, if one potential is always higher than the other, such as a battery, it is DC voltage. In DC the higher potential is called positive and the lower potential is called negative.
Weld Cable	This is the large diameter cable which carries the power for the pilot arc and the welding current to the arc stud.